

LED DR. BRIGHT

LIGHTING NEW PRODUCT CATALOG

2024 LED照明目錄

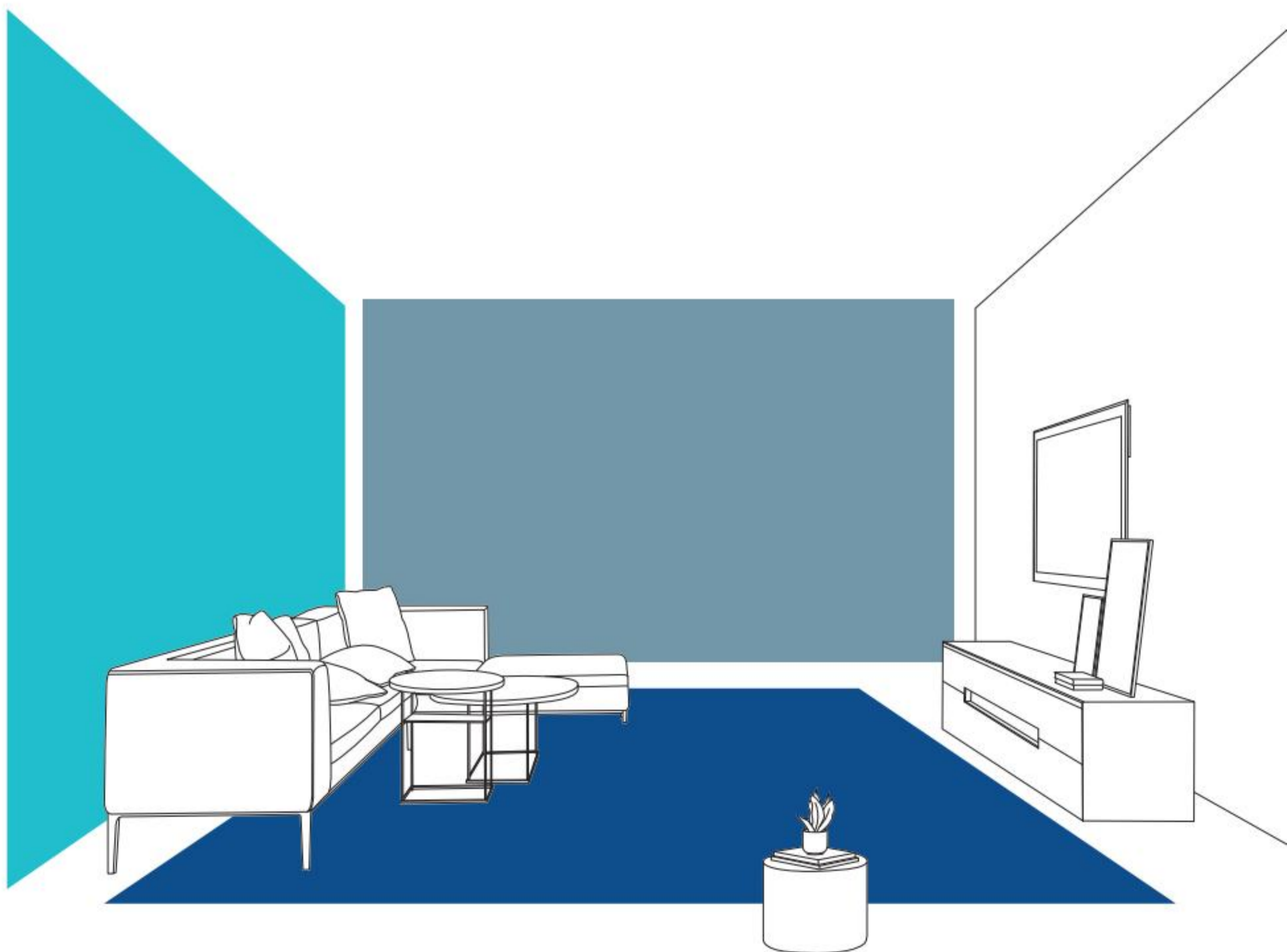

Contents

- 1. 目次
- 2. 產品認證書
- 3.~ 21. LED 吸頂燈 系列
- 22.~ 24. LED 防潮燈 系列
- 25.~ 27. LED 壁切四段調色 系列
- 28.~ 31. LED 紅外線感應 系列
- 32.~ 37. LED 球泡燈 系列
- 38.~ 41. LED 大瓦數球泡燈 系列
- 42.~ 44. LED 圓形燈泡 系列
- 45.~ 46. LED 飛碟燈 系列
- 47.~ **49.** LED 嵌燈 系列
- 50. LED MR16免安杯燈 系列
- 51. LED T8玻璃燈管 系列
- 52. LED T5全塑支架燈 系列
- 53. LED 超薄平板燈
- 54. LED 水晶燈 系列
- 55.~57. **新品上市**



配光曲線圖



獲得多項國家認證

買的**放心** 用的**安心**





LED 吸頂燈系列
為您打造不一樣的居家環境



6大安心防護!

亮博士產品

他牌產品



第一道防蚊蟲



獨家專利技術，蚊蟲無法輕易飛入燈體內。

蚊蟲容易飛入燈體內死亡，殘存的屍體，會形成燈罩上的髒污與黑斑。



第二道防塵設計



通過IP54防塵、防水測試，灰塵不易穿入燈體內，且易於清潔。

無防塵設計，使用一段時間，燈體內會有灰塵髒污堆積。

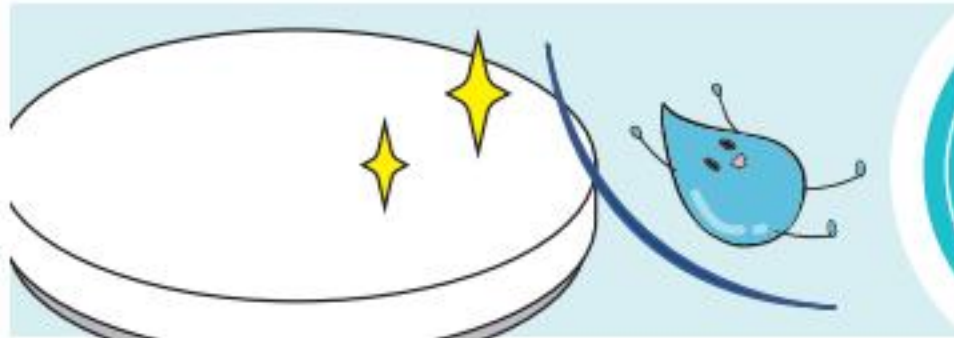

第三道防水設計



通過IP54防塵、防水測試，適用於浴廁等，潮濕場域。

無防水等級，潮濕場域使用，燈具壽命受限，甚至可能短路或著火。



第四道防鏽設計



燈體與底座，皆使用通過耐燃測試塑料生產，無鏽蝕問題。

使用鋁材或鐵材，在台灣潮濕環境中，易於掉漆鏽蝕，甚至損壞結構而脫落。

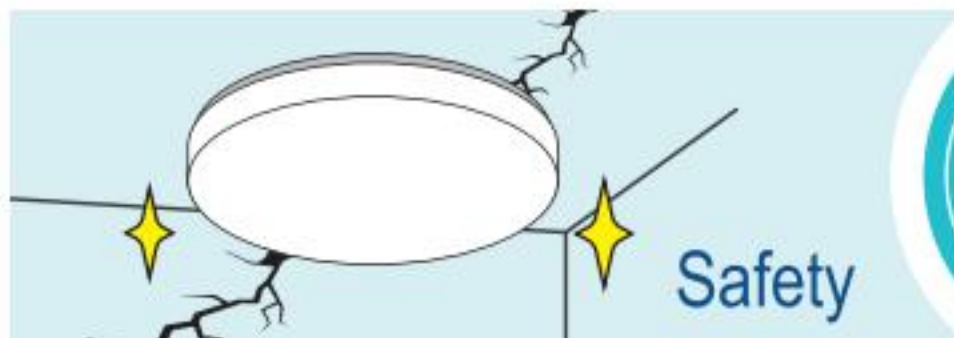

第五道防震設計



燈體與底座，皆通過2倍負重測試，地震搖晃，不至於鬆脫或龜裂。

許多產品使用薄板成形，固定後，如遇搖晃，薄板易於變形鬆脫，造成危險。



第六道防觸電



燈體與底座，皆使用不導電塑料生產，無觸電問題。

許多產品使用鐵、鋁材料，易因短路，而有觸電危險。

專利 快裝快拆 結構設計!

方形底座 專利證號 M526646

STEP ①

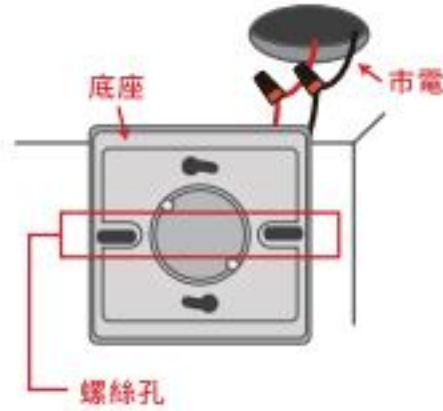

將底座電線與市電電線連接後，將底座鎖固於天花板。

STEP ②

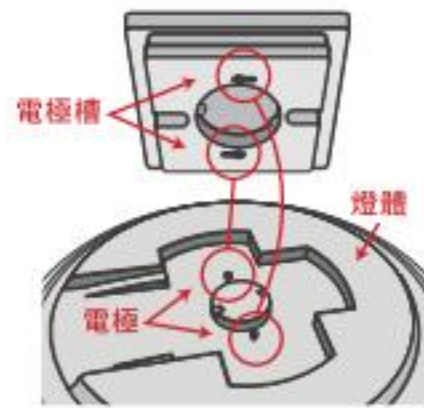

將燈體後方電極，對準底座電極槽，水平往上接合。

STEP ③

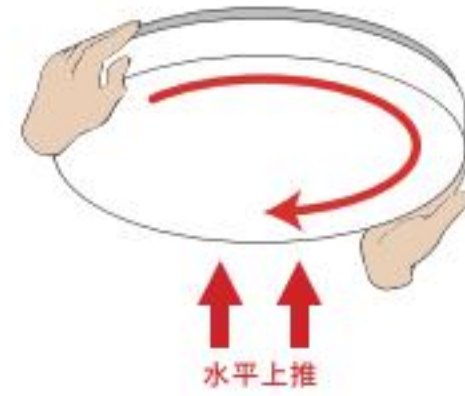

水平上推，並順時針旋轉卡緊。

圓形底座 專利證號 M526646 M597030

STEP ①



將底座電線與市電電線連接後，將底座鎖固於天花板。

STEP ②

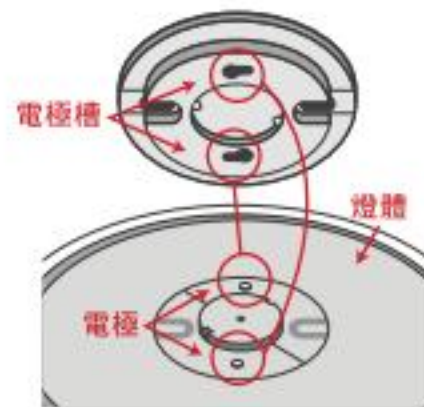

將燈體後方電極，對準底座電極槽，水平往上接合。

STEP ③

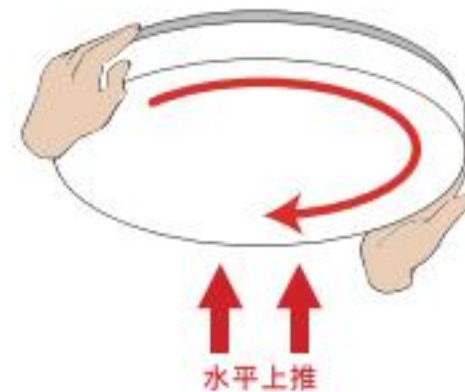

水平上推，並順時針旋轉卡緊。

新水壺頭底座 專利證號 M579247 M596847

STEP ①



將底座電線與市電電線連接後，將底座鎖固於天花板。

STEP ②



將底座鋼索扣環，扣住燈體後方扣槽。

STEP ③



燈體扣槽位置對準鋼索出線孔，水平往上。將燈體卡點對準底座卡槽接合。

STEP ④

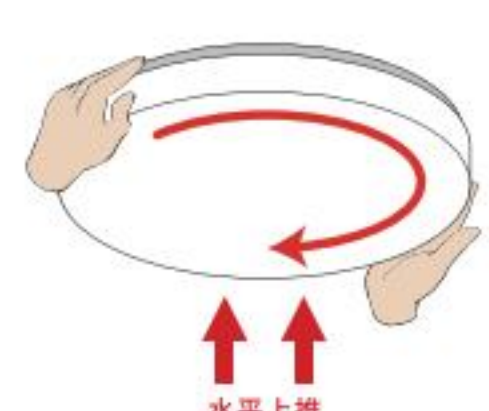

水平上推，並順時針旋轉卡緊。

吸頂燈功能介紹!

牆壁開關三段調光

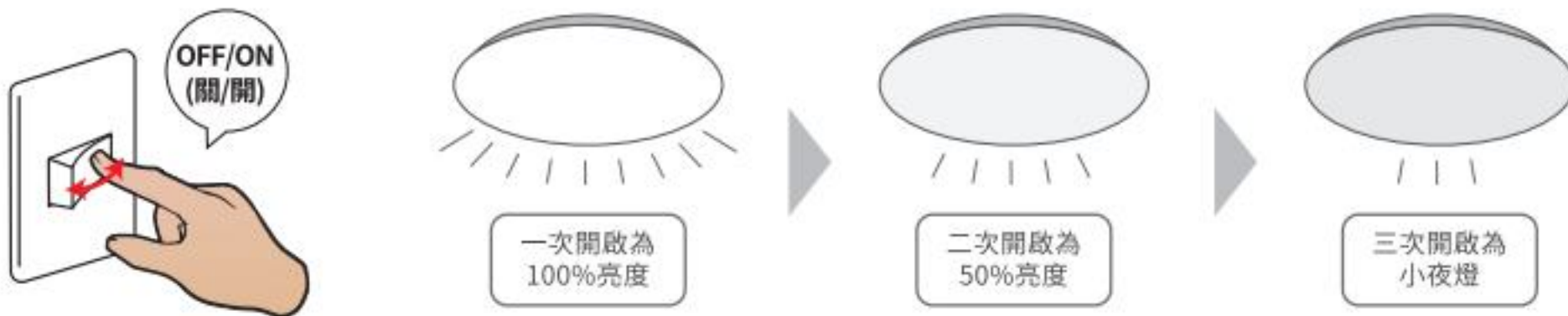

※備註：① 電源關閉後10秒內無再次開啟，則回復至100%亮度。 ② 牆壁開關切換與遙控系統分開。 ③ 此功能無法調色。
④ 42W壁切款小夜燈為10%亮度，48W以上遙控款小夜燈為黃光。

遙控器功能介紹



新版吸頂燈功能介紹!

牆壁開關四段調色

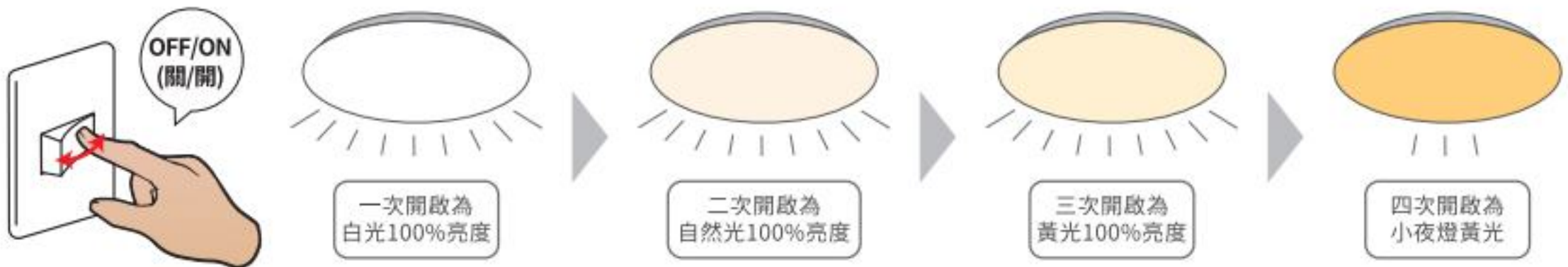

※備註：① 開燈後7秒內未切換，記憶當下色溫。 ② 牆壁開關切換與遙控控制系統分開。
③ 牆壁開關四段調色功能只有56.8W開運吸頂燈、新版60W吸頂燈、90W吸頂燈等款式。

新版遙控器功能介紹

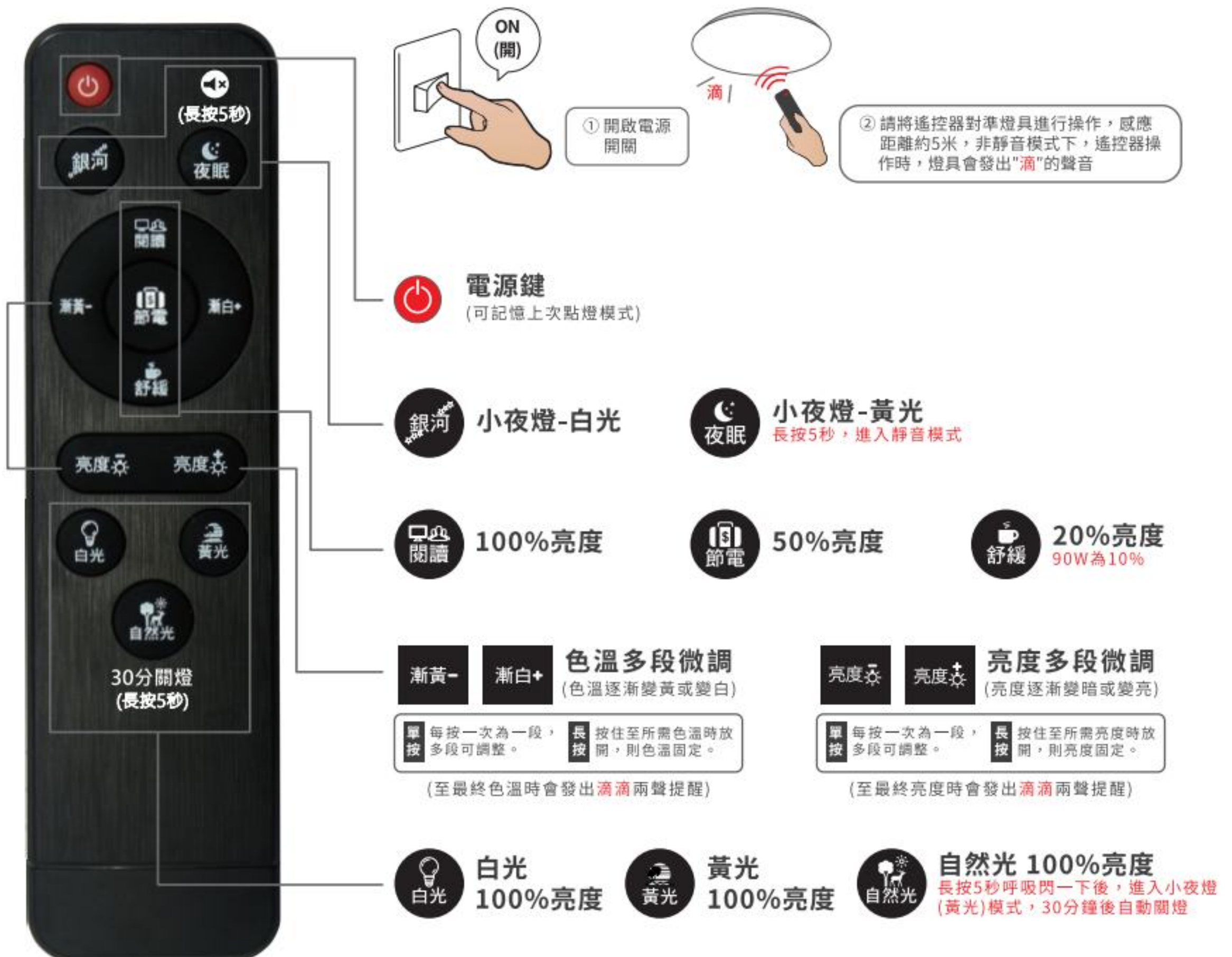



新品上市

LED 抑菌吸頂燈(星空款)



通過
CNS認證



適用電壓
100-240
Vac



RoHS



簡易安裝



防塵防水



抑菌

TTA奈米抗菌塗層

開燈可增加塗層抗菌效果



抑制細菌與病毒的生長

SGS實驗證明，塗層有效降低空氣中細菌與病毒的活性，並抑制其生長。

預防黴菌孳生

SGS實驗證明，塗層可以有效預防黴菌繁殖。

去除空氣中的甲醛

SGS實驗證明，塗層可以持續分解空氣中的甲醛，淨化空氣。

防水IP54

通過IP54防水測試，適用於浴廁等，潮濕場域。

無紫外線

獨家技術，無須紫外光，即可觸動光觸媒。

防汗

燈罩塗層，可長期保持潔淨，並提高照明效率。





LED 抑菌吸頂燈(滿月款)



抑菌



防塵防水



簡易安裝



RoHS



適用電壓



通過 CNS 認證

功能/款式	牌價	建議坪數	功率	色溫	光通量(帶罩)	演色性	防護等級	底座	產品尺寸(mm)
單色 星空款	\$890	1-2坪	18W	F4000	1280Lm	Ra80	IP54	GX53方形 專利底座	Ø253x82±5mm
單色 滿月款	\$890	1-2坪	18W	F6500	1280Lm	Ra80	IP54	GX53方形 專利底座	Ø253x82±5mm

SGS 檢驗合格



LED **開運** 吸頂燈

超旺財氣設計

專利證號 D226831

元寶開運

元寶外型圓弧修飾，具有「處事圓融，廣結善緣」之意

聚寶加持

元寶圖樣朝中心匯集，具有「海納百川，招財進寶」之意。

文公尺開運尺寸

進寶 招財進寶

迎福 迎接幸福

益利 增加財資利祿

納福 享受福分

喜事 遇見值得慶賀的事

六合 天地四方，合和美滿

財旺 財運好，發大財

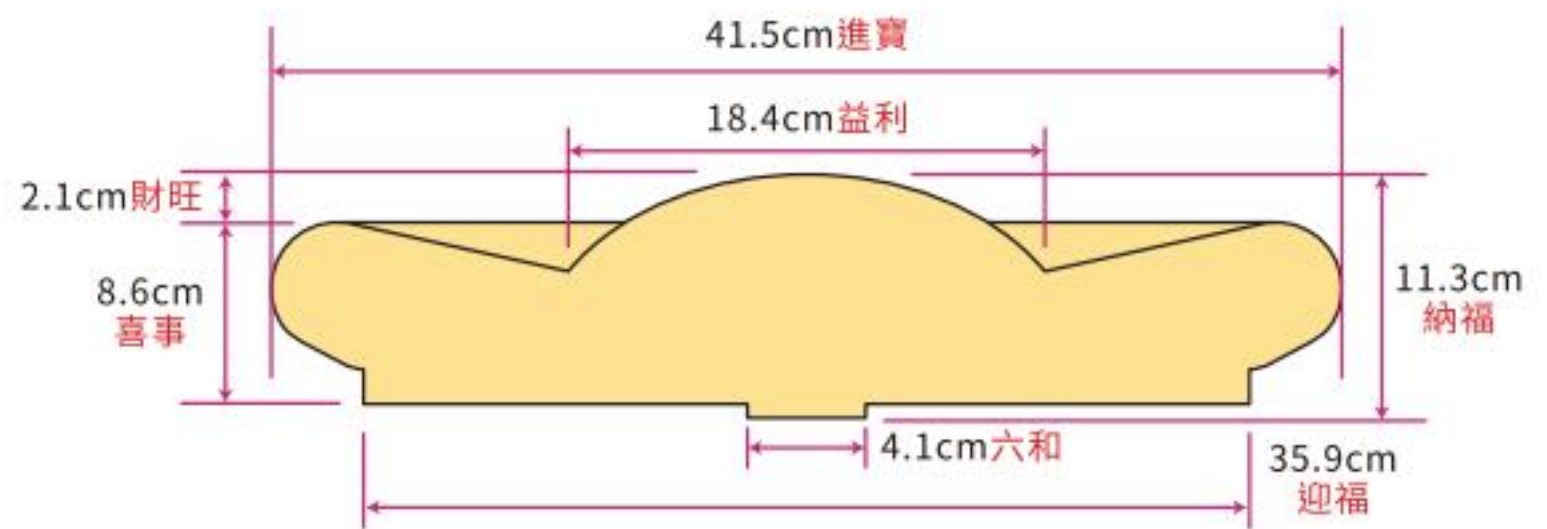

開運遙控器功能介紹

Remote control device with various function buttons and their descriptions:

- 30分關燈** (30 min off)
- 電源鍵** (Power button)
- 靜音開關** (Silent switch)
- 30分鐘定時關燈** (30 min timer off): 小夜燈(黃光)模式，30分鐘後自動關燈
- 小夜燈-白光** (Night light - white light)
- 小夜燈-黃光** (Night light - yellow light)
- 100%亮度** (100% brightness)
- 50%亮度** (50% brightness)
- 10%亮度** (10% brightness)
- 黃光 100%亮度** (Yellow light 100% brightness)
- 自然光 100%亮度** (Natural light 100% brightness)
- 白光 100%亮度** (White light 100% brightness)
- 色溫多段微調** (Color temperature multi-segment fine-tuning): (色溫逐漸變黃或變白)
 - 漸黃 (Yellow)
 - 漸白 (White)
 - 單按: 每按一次為一段，多段可調整。
 - 長按: 按住至所需色溫時放開，則色溫固定。
 - (至最終色溫時會發出滴滴兩聲提醒)
- 亮度多段微調** (Brightness multi-segment fine-tuning): (亮度逐漸變暗或變亮)
 - 漸暗 (Dimmer)
 - 漸亮 (Brighter)
 - 單按: 每按一次為一段，多段可調整。
 - 長按: 按住至所需亮度時放開，則亮度固定。
 - (至最終亮度時會發出滴滴兩聲提醒)
- 中心黃光開關** (Center yellow light switch)



新品上市

LED 開運吸頂燈



防塵防水



簡易安裝



RoHS



適用電壓



通過 CNS 認證



白光 F6500

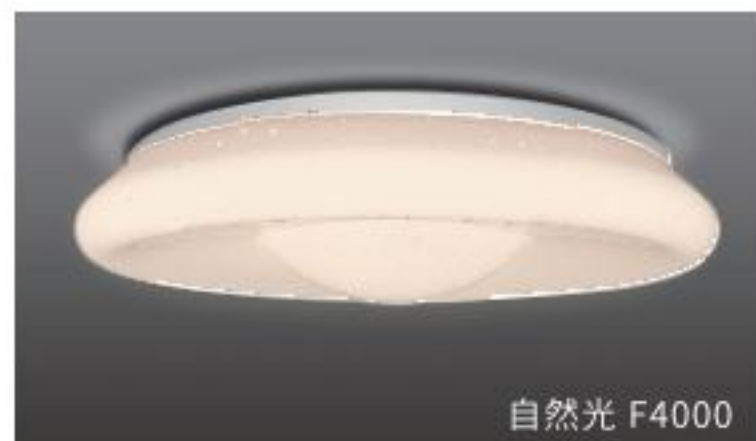

自然光 F4000

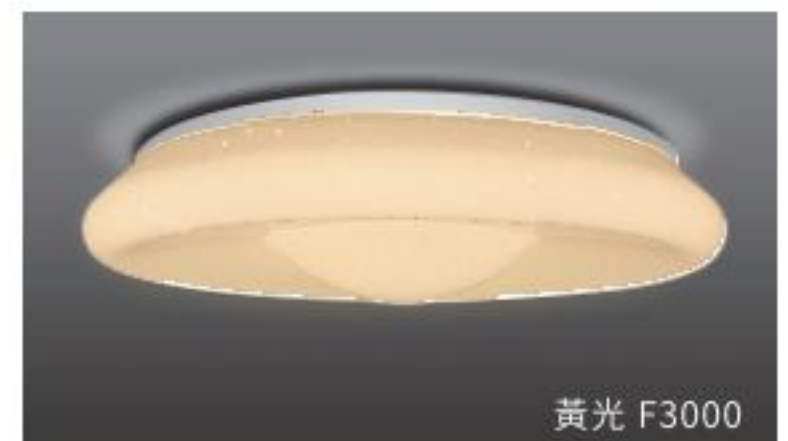

黃光 F3000

功能類型	牌價	建議坪數	功率	色溫	光通量(帶罩)	演色性	防護等級	底座	產品尺寸(mm)
單色	\$2,680	5-7坪	51.8W	F6500 F4000 F3000	5200Lm 5200Lm 5200Lm	Ra80	IP54	GX53圓形 專利底座	Ø415x113±5mm
遙控多段 調光調色	\$5,280	5-7坪	56.8W	F6500 F3000	5680Lm (Max.)	Ra80	IP54	GX53圓形 專利底座	Ø415x113±5mm
遙控多段 調光調色	洽詢業務		90W	F6500 F3000	預計Q4上市				



LED 森活吸頂燈

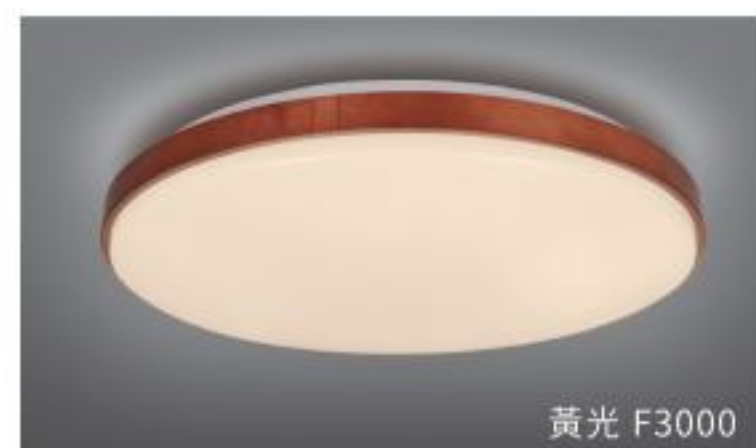
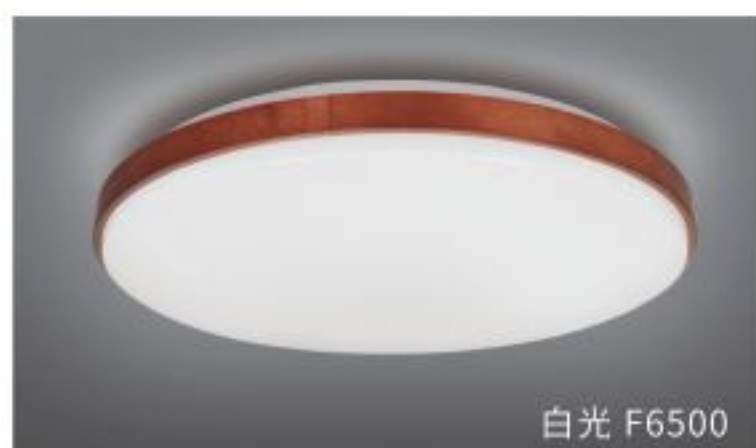

功能類型	牌價	建議坪數	功率	色溫	光通量(帶罩)	演色性	防護等級	底座	產品尺寸(mm)
遙控多段調光調色	\$7,350	5-7坪	60W	F6500 F3000	5600Lm (Max.)	Ra80	IP50	新水壺頭專利底座	Ø500x100±5mm
遙控多段調光調色	\$16,000	9-11坪	100W	F6500 F3000	10000Lm (Max.)	Ra80	IP50	新水壺頭專利底座	Ø770x125±5mm

另有多款木框色系可供挑選



原木色



詩肯柚木色



LED 恆宇吸頂燈

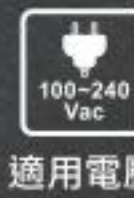

功能類型	牌價	建議坪數	功率	色溫	光通量(帶罩)	演色性	防護等級	底座	產品尺寸(mm)
遙控多段 調光調色	\$5,000	5-7坪	60W	F6500 F3000	4600Lm (Max.)	Ra80	IP50	新水壺頭 專利底座	Ø515x110±5mm



LED 圓滿吸頂燈



通過
CNS認證



100-240
Vac
適用電壓



RoHS



簡易安裝



防塵防水



白光 F6500



自然光 F4000



黃光 F3000

功能類型	牌價	建議坪數	功率	色溫	光通量(帶罩)	演色性	防護等級	底座	產品尺寸(mm)
單色	\$1,280	4-6坪	50W	F6500 F4000 F3000	5000Lm 5000Lm 5000Lm	Ra80	IP54	GX53圓形 專利底座	Ø448x103±5mm



LED 日系吸頂燈



防塵防水



簡易安裝



RoHS



適用電壓



通過
CNS認證



白光 F6500



自然光 F4000



黃光 F3000

功能類型	牌價	建議坪數	功率	色溫	光通量(帶罩)	演色性	防護等級	底座	產品尺寸(mm)
單色	\$900	2-3坪	20W	F6500 F4000 F3000	2000Lm 2000Lm 1900Lm	Ra80	IP54	GX53圓形 專利底座	Ø250x68±5mm



LED 月曜吸頂燈



通過
CNS認證



100-240
Vac
適用電壓



RoHS



簡易安裝



防塵防水



白光 F6500



自然光 F4000



黃光 F3000

功能類型	牌價	建議坪數	功率	色溫	光通量(帶罩)	演色性	防護等級	底座	產品尺寸(mm)
牆壁開關 三段調光	\$1,800	3-4坪	42W	F6500 F3000	3420Lm 3420Lm	Ra80	IP54	GX53方形 專利底座	Ø440x102±5mm
遙控多段 調光調色	\$3,600	3-5坪	48W	F6500 F3000	4800Lm (Max.)	Ra80	IP54	GX53方形 專利底座	Ø440x102±5mm
遙控多段 調光調色	\$5,000	5-7坪	60W	F6500 F3000	5600Lm (Max.)	Ra80	IP50	新水壺頭 專利底座	Ø560x105±5mm
遙控多段 調光調色	\$13,000	9-11坪	100W	F6500 F3000	10000Lm (Max.)	Ra80	IP50	新水壺頭 專利底座	Ø760x145±5mm



LED 星晨吸頂燈



防塵防水



簡易安裝



RoHS



適用電壓



通過
CNS認證

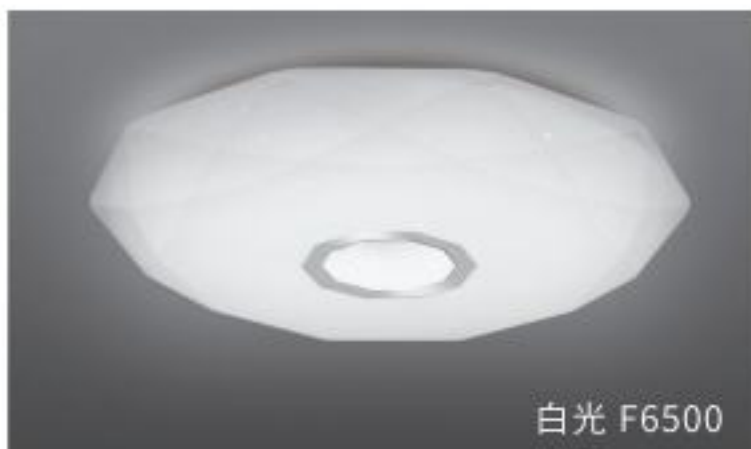

白光 F6500

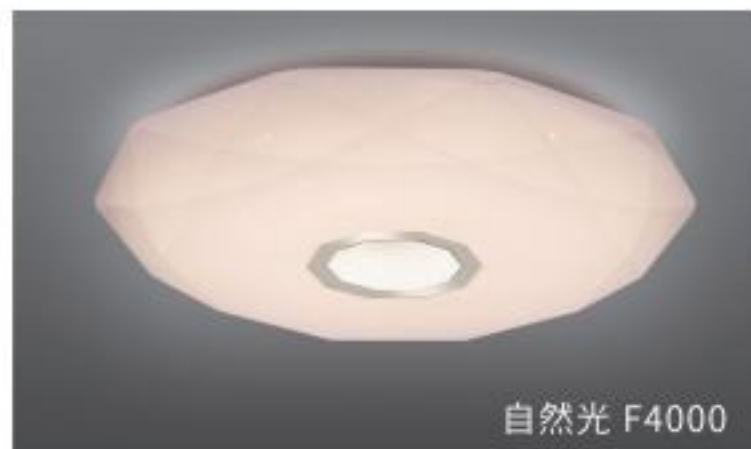

自然光 F4000

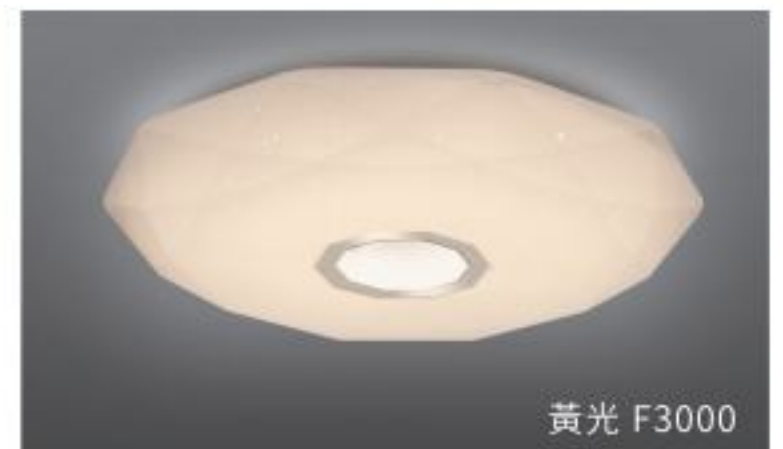

黃光 F3000

功能類型	牌價	建議坪數	功率	色溫	光通量(帶罩)	演色性	防護等級	底座	產品尺寸(mm)
牆壁開關 三段調光	\$1,800	3-4坪	42W	F6500 F4000 F3000	3420Lm 3420Lm 3420Lm	Ra80	IP54	GX53方形 專利底座	Ø440x102±5mm
遙控多段 調光調色	\$3,600	3-5坪	48W	F6500 F3000	4800Lm (Max.)	Ra80	IP54	GX53方形 專利底座	Ø440x102±5mm
遙控多段 調光調色	\$5,000	5-7坪	60W	F6500 F3000	5600Lm (Max.)	Ra80	IP50	新水壺頭 專利底座	Ø560x105±5mm



LED 星空吸頂燈



90W 獨家漣漪款
壁切2段/遙控調光調色



通過
CNS認證



100~240
Vac
適用電壓



RoHS



簡易安裝



防塵防水



白光 F6500



自然光 F4000



黃光 F3000

功能類型	牌價	建議坪數	功率	色溫	光通量(帶罩)	演色性	防護等級	底座	產品尺寸(mm)
單色	\$580	1-2坪	18W	F6500 F4000 F3000	1600Lm 1600Lm 1500Lm	Ra80	IP54	GX53方形 專利底座	Ø253x82±5mm
單色	\$950	2-3坪	28W	F6500 F4000 F3000	2250Lm 2250Lm 2025Lm	Ra80	IP54	GX53方形 專利底座	Ø320x92±5mm
牆壁開關 三段調光	\$1,800	3-4坪	42W	F6500 F3000	3420Lm 3420Lm	Ra80	IP54	GX53方形 專利底座	Ø440x102±5mm
遙控多段 調光調色	\$3,600	3-5坪	48W	F6500 F3000	4800Lm (Max.)	Ra80	IP54	GX53方形 專利底座	Ø440x102±5mm
遙控多段 調光調色	\$5,000	5-7坪	60W	F6500 F3000	5600Lm (Max.)	Ra80	IP50	新水壺頭 專利底座	Ø560x105±5mm
遙控多段 調光調色	\$11,000	8-10坪	90W	F6500 F3000	9000Lm (Max.)	Ra80	IP50	新水壺頭 專利底座	Ø720x146±5mm
壁切2段 單色	\$8,500	8-10坪	90W	F6500 F4000 +小夜燈	9000Lm (Max.)	Ra80	IP50	新水壺頭 專利底座	Ø720x146±5mm



LED 星鑽吸頂燈



防塵防水



簡易安裝



RoHS



適用電壓



通過
CNS認證

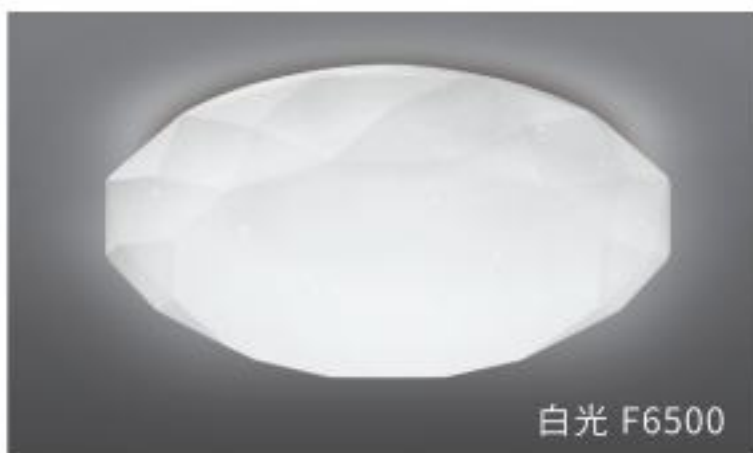

白光 F6500

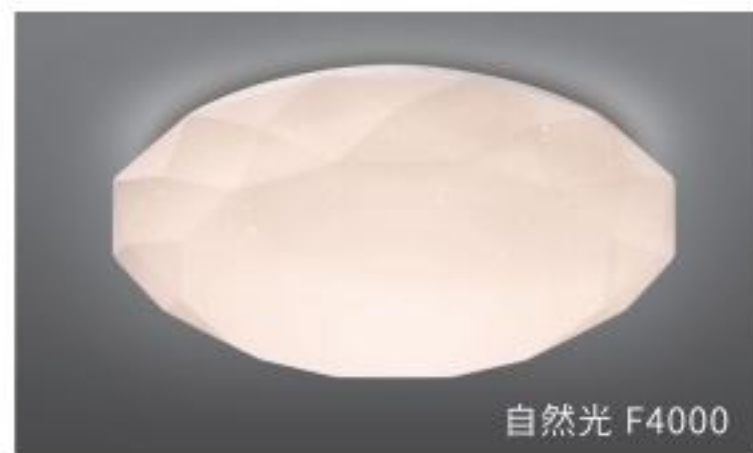

自然光 F4000

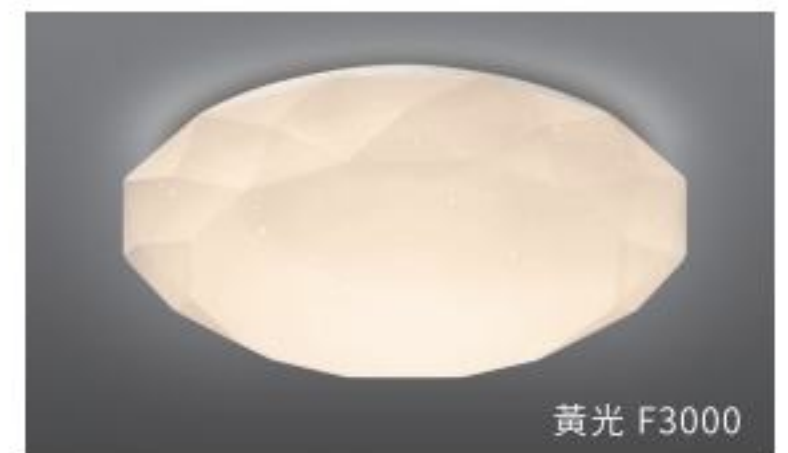

黃光 F3000

功能類型	牌價	建議坪數	功率	色溫	光通量(帶罩)	演色性	防護等級	底座	產品尺寸(mm)
單色	\$580	1-2坪	18W	F6500 F3000	1600Lm 1500Lm	Ra80	IP54	GX53方形 專利底座	Ø253x82±5mm
單色	\$950	2-3坪	28W	F6500 F4000 F3000	2250Lm 2250Lm 2025Lm	Ra80	IP54	GX53方形 專利底座	Ø320x92±5mm
牆壁開關 三段調光	\$1,800	3-4坪	42W	F6500 F4000 F3000	3420Lm 3420Lm 3420Lm	Ra80	IP54	GX53方形 專利底座	Ø440x102±5mm
遙控多段 調光調色	\$3,600	3-5坪	48W	F6500 F3000	4800Lm (Max.)	Ra80	IP54	GX53方形 專利底座	Ø440x102±5mm
遙控多段 調光調色	\$5,000	5-7坪	60W	F6500 F3000	5600Lm (Max.)	Ra80	IP50	新水壺頭 專利底座	Ø560x105±5mm
遙控多段 調光調色	洽詢業務		90W	F6500 F3000	洽詢業務				
遙控多段 調光調色	\$13,000	9-11坪	100W	F6500 F3000	10000Lm (Max.)	Ra80	IP50	新水壺頭 專利底座	Ø720x145±5mm

*100W星鑽改版中-預計4月底上市



LED 滿月吸頂燈



防塵防水



簡易安裝



RoHS



適用電壓



通過
CNS認證



白光 F6500

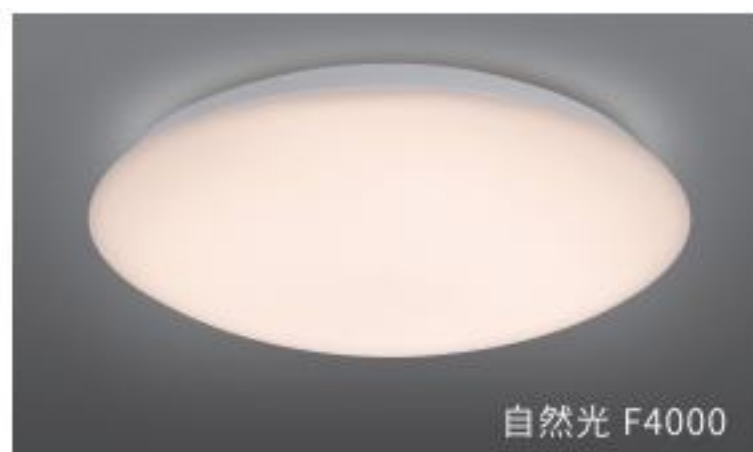

自然光 F4000



黃光 F3000

功能類型	牌價	建議坪數	功率	色溫	光通量(帶罩)	演色性	防護等級	底座	產品尺寸(mm)
單色	\$580	1-2坪	18W	F6500 F3000	1280Lm 1200Lm	Ra80	IP54	GX53方形 專利底座	Ø253x82±5mm
單色	\$950	2-3坪	28W	F6500 F4000 F3000	2250Lm 2250Lm 2025Lm	Ra80	IP54	GX53方形 專利底座	Ø320x92±5mm
牆壁開關 三段調光	\$1,800	3-4坪	42W	F6500 F4000 F3000	3420Lm 3420Lm 3420Lm	Ra80	IP54	GX53方形 專利底座	Ø440x102±5mm
遙控多段 調光調色	\$3,600	3-5坪	48W	F6500 F3000	4800Lm (Max.)	Ra80	IP54	GX53方形 專利底座	Ø440x102±5mm
遙控多段 調光調色	\$5,000	5-7坪	60W	F6500 F3000	5600Lm (Max.)	Ra80	IP50	新水壺頭 專利底座	Ø560x105±5mm



LED 蛋糕吸頂燈



通過
CNS認證

100-240
Vac
適用電壓

RoHS

簡易安裝

防塵防水

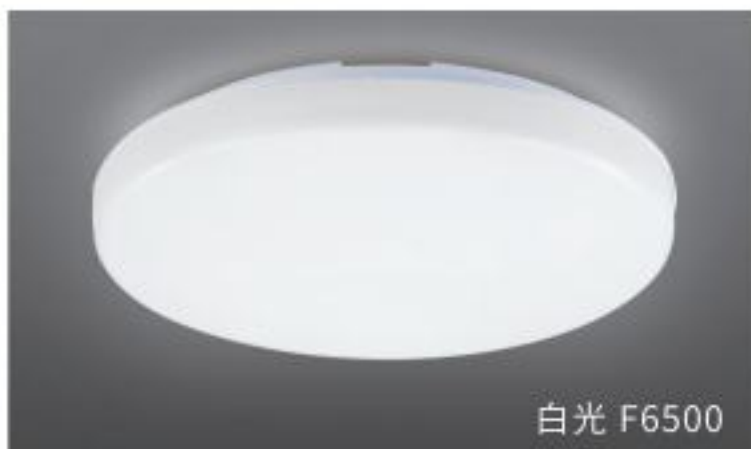

白光 F6500



自然光 F4000



黃光 F3000

功能類型	牌價	建議坪數	功率	色溫	光通量(帶罩)	演色性	防護等級	底座	產品尺寸(mm)
單色	\$500	1-2坪	15W	F6500 F4000 F3000	1600Lm 1600Lm 1500Lm	Ra80	IP54	GX53圓形 專利底座	Ø220x70±5mm
單色	\$900	2-3坪	28W	F6500 F3000	2250Lm 2025Lm	Ra80	IP54	GX53方形 專利底座	Ø280x75±5mm
遙控多段 調光調色	\$5,000	5-7坪	60W	F6500 F3000	5600Lm (Max.)	Ra80	IP50	新水壺頭 專利底座	Ø560x105±5mm
遙控多段 調光調色	\$13,000	9-11坪	100W	F6500 F3000	10000Lm (Max.)	Ra80	IP50	新水壺頭 專利底座	Ø760x145±5mm

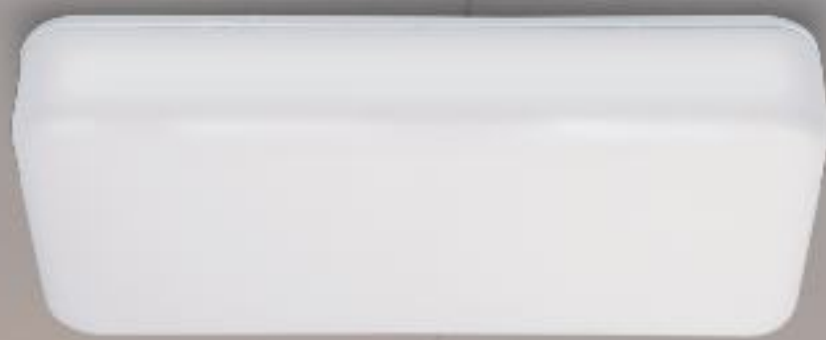

LED 防潮燈系列

陽台、玄關、浴室，最佳選擇





亮面橢圓形



亮面圓形

LED 防潮吸頂/壁掛兩用燈



專利快速安裝設計

專利證號：M594103

圓形及長方形

STEP ①

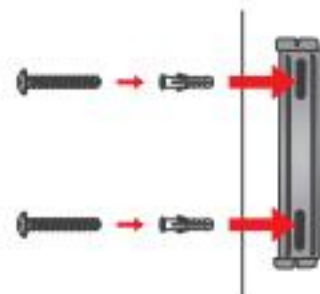

將不鏽鋼鐵片固定於施作牆面。

STEP ②

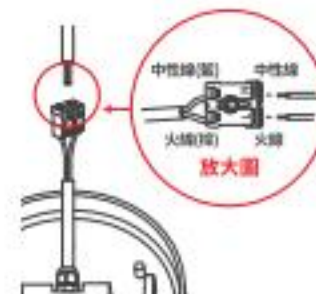

將AC電源線確實連接。

STEP ③

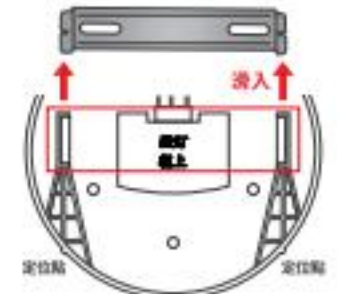

定位點朝下，將燈體凹槽固定於不鏽鋼鐵片兩端位置(咯一聲)即可完成安裝。

橢圓形

STEP ①

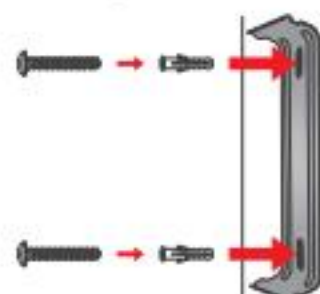

將不鏽鋼鐵片固定於施作牆面。

STEP ②

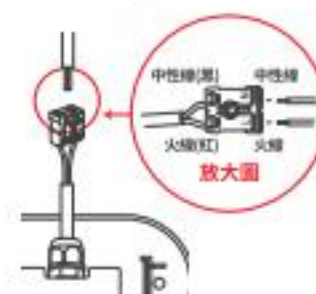

將AC電源線確實連接。

STEP ③

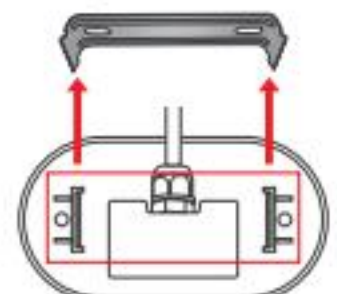

將燈體背面卡點垂直方向卡入不鏽鋼鐵片凹槽固定，即可完成安裝。



適用各種環境



款式	功能類型	牌價	建議坪數	功率	色溫	光通量	演色性	防護等級	產品尺寸(mm)
亮面橢圓形	單色	\$300	1-2坪	10W	F3000	900Lm	Ra80	IP65	L176xW85xH46±5mm
亮面圓形	單色	\$330	1-2坪	12W	F6500 F4000 F3000	1200Lm 1200Lm 1200Lm	Ra80	IP65	Ø160x46±5mm
日系圓形	單色	\$370	1-2坪	12W	F6500 F4000 F3000	1200Lm 1200Lm 1200Lm	Ra80	IP65	Ø160x46±5mm
日系長方形	單色	\$590	1-2坪	14W	F6500 F3000	1400Lm 1400Lm	Ra80	IP65	L260xW112xH46±5mm

LED 壁切四段調色系列

開關四段調色，實用又省電



新品上市

LED 壁切四段調色吸頂燈 (晨曦款)



功能類型	牌價	建議坪數	功率	色溫	光通量(帶罩)	演色性	防護等級	底座	產品尺寸(mm)
牆壁開關 四段調色	業務報價	4-6坪	55W	F6500 F4000 F3000 F2200	5500Lm (Max.) 2200K小夜燈	Ra80	IP54	GX53圓形 專利底座	Ø397x77±5mm

牆壁開關切換



※備註：開燈後5秒內未切換，記憶當下色溫。

LED 壁切四段調色球泡燈

新品上市



四段調色

13W



白光 F6500

自然光 F4000

黃光 F3000

小夜燈 F2200

功能類型	功率	取代市售	色溫	光通量	光效	演色性	燈頭	產品尺寸(mm)
牆壁開關 四段調色	13W	 23W 螺旋	F6500 F4000 F3000 F2200	1560Lm (Max.) 2200K小夜燈	120Lm/W	Ra80	E27	Ø60x124±5mm



高亮度



無藍光危害



低頻閃抑制



光生物安全



RoHS



適用電壓



通過
CNS認證



LED 紅外線感應 系列

感應自動亮燈，舒適又便利



LED 紅外線感應吸頂燈



適用電壓



簡易安裝



紅外線感應



白光 F6500



自然光 F4000



黃光 F3000

功能類型	牌價	建議坪數	功率	色溫	光通量(帶罩)	演色性	功率因數	底座	產品尺寸(mm)
第一代 紅外線感應	\$920	1-2坪	15W	F6500 F4000 F3000	1600Lm 1600Lm 1500Lm	Ra80	0.5	GX53方形 專利底座	Ø220x80±5mm
第二代 牆壁開關二段 循環切換	\$1,180	1-2坪	15W	F6500 F4000 F3000	1600Lm 1600Lm 1500Lm	Ra80	0.5	GX53方形 專利底座	Ø220x80±5mm
第一代 紅外線感應	\$1,400	2-3坪	25W	F6500 F4000 F3000	2100Lm 2100Lm 2000Lm	Ra80	0.5	GX53方形 專利底座	Ø280x86.5±5mm

第一代 紅外線感應

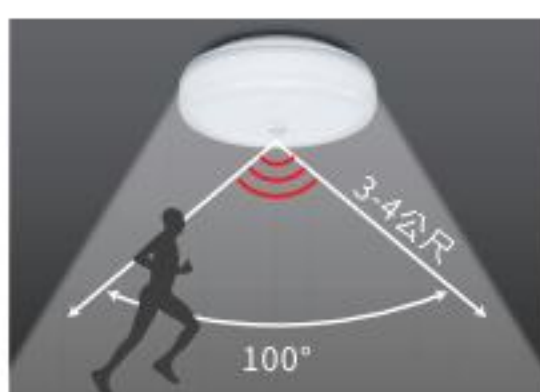

100°大範圍感應，感應距離約3-4公尺。進入感應範圍內，即刻亮燈，偵測不到人體活動90秒內自動熄滅。

第二代 牆壁開關二段 循環切換

買一顆抵兩顆!



第一段

開關開啟，燈具閃3下後，立即進入感應模式。



第二段

關燈後，再次開啟開關，持續全亮點燈。

LED 紅外線感應飛碟燈



12W



功能類型	功率	取代市售	色溫	光通量	光效	演色性	燈頭	產品尺寸(mm)
紅外線感應	12W	 19W 螺旋	F6500 F4000 F3000	1055Lm 1055Lm 1055Lm	88Lm/W 88Lm/W 88Lm/W	Ra80	E27	Ø137x80±5mm

紅外線感應

100°大範圍感應，感應距離約3-4公尺。進入感應範圍內，即刻亮燈，偵測不到人體活動90秒內自動熄滅。



適用電壓

LED 紅外線感應嵌燈



15W

功能類型	功率	色溫	光通量	光效	演色性	壽命	開孔尺寸	產品尺寸(mm)
紅外線感應	15W	F6500 F4000 F3000	1300Lm 1300Lm 1200Lm	87Lm/W 87Lm/W 80Lm/W	Ra80	15,000h	Ø15cm	Ø187x45±5mm

紅外線感應

100°大範圍感應，感應距離約3-4公尺。進入感應範圍內，即刻亮燈，偵測不到人體活動90秒內自動熄滅。

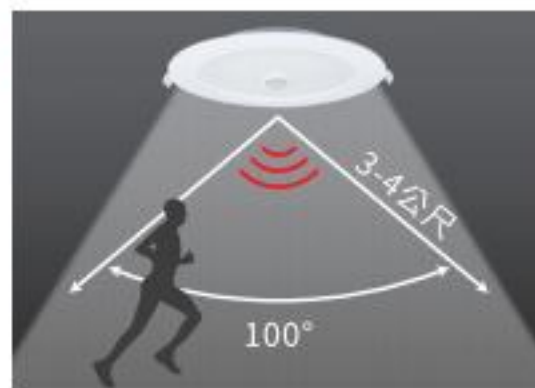

附加快接端子



適用電壓





LED 球泡燈系列

一次滿足您對燈的需求



LED Mini燈泡系列



功率	取代市售	色溫	光通量	光效	演色性	壽命	燈頭	產品尺寸(mm)
8.5W	 14W 螺旋	F6500 F4000 F3000	900Lm 900Lm 900Lm	106Lm/W 106Lm/W 106Lm/W	Ra80	15,000h	E14 E27	Ø40x113±5mm Ø40x109±5mm
14W	 28W 螺旋	F6500 F4000 F3000	1800Lm 1800Lm 1650Lm	129Lm/W 129Lm/W 118Lm/W	Ra80	15,000h	E27	Ø45x146±5mm
45W	 85W 螺旋	F6500 F4000 F3000	6100Lm 6100Lm 5800Lm	136Lm/W 136Lm/W 129Lm/W	Ra80	15,000h	E27 E40	Ø105x254±5mm Ø105x264±5mm



高亮度



無藍光危害



低頻閃抑制



光生物安全



RoHS



適用電壓





通過
CNS認證

LED 穩壓球泡燈 系列

新品上市

適用於電壓不穩定場所，有效抑制燈光閃爍抖動造成眼睛的不適



功率	取代市售	色溫	光通量	光效	演色性	壽命	燈頭	產品尺寸(mm)
3W	 5W 螺旋	F6500 F3000	320Lm 320Lm	107Lm/W 107Lm/W	Ra80	15,000h	E27	Ø45x84±5mm
5W	 10W 螺旋	F6500 F3000	525Lm 525Lm	105Lm/W 105Lm/W	Ra80	15,000h	E14 E27	Ø50x93±5mm Ø50x91±5mm
7.5W	 14W 螺旋	F6500 F3000	800Lm 800Lm	107Lm/W 107Lm/W	Ra80	15,000h	E27	Ø55x100±5mm

*5W E14非穩壓系列



適用於電壓不穩定場所，有效抑制燈光閃爍抖動造成眼睛的不適



LED 穩壓球泡燈 系列

新品上市





10W



13W



16W

功率	取代市售	色溫	光通量	光效	演色性	壽命	燈頭	產品尺寸(mm)
10W	 19W 螺旋	F6500 F4000 F3000	1200Lm 1200Lm 1150Lm	120Lm/W 120Lm/W 115Lm/W	Ra80	4,000h (持續測試中)	E27	Ø60x118±5mm
13W	 27W 螺旋	F6500 F4000 F3000	1560Lm 1560Lm 1495Lm	120Lm/W 120Lm/W 115Lm/W	Ra80	4,000h (持續測試中)	E27	Ø60x118±5mm
16W	 28W 螺旋	F6500 F4000 F3000	1920Lm 1920Lm 1840Lm	120Lm/W 120Lm/W 115Lm/W	Ra80	4,000h (持續測試中)	E27	Ø70x137±5mm



高光效



無藍光危害



低頻閃抑制



光生物安全



RoHS



適用電壓



通過
CNS認證

適用於電壓不穩定場所，有效抑制燈光閃爍抖動造成眼睛的不適



LED 穩壓球泡燈 系列

新品上市



20W



25W

功率	取代市售	色溫	光通量	光效	演色性	壽命	燈頭	產品尺寸(mm)
20W	36W 螺旋	F6500 F3000	2400Lm 2300Lm	120Lm/W 115Lm/W	Ra80	15,000h	E27	Φ 75x137mm±5mm
25W	45W 螺旋	F6500 F3000	3000Lm 2875Lm	120Lm/W 115Lm/W	Ra80	15,000h	E27	Φ 90x184mm±5mm



無藍光危害



低頻閃抑制



光生物安全



RoHS



適用電壓





通過
CNS認證

LED 大瓦數球泡燈系列

提供高亮度又省電的照明產品

LED 大瓦數球泡燈 系列



功率	取代市售	色溫	光通量	光效	演色性	壽命	燈頭	產品尺寸(mm)
35W	 80W 螺旋	F6500 F4000 F3000	4600Lm 4600Lm 4600Lm	131Lm/W 131Lm/W 131Lm/W	Ra80	15,000h	E27	Ø120x212±5mm
42W	 105W 螺旋	F6500 F4000 F3000	6000Lm 6000Lm 5600Lm	143Lm/W 143Lm/W 133Lm/W	Ra80	15,000h	E27 E40	Ø130x230±5mm Ø130x240±5mm



高光效



無藍光危害



低頻閃抑制



光生物安全



RoHS





適用電壓



通過
CNS認證

LED 大瓦數球泡燈 防水系列



功率	取代市售	色溫	光通量	光效	演色性	壽命	燈頭	產品尺寸(mm)
55W	 105W以上 螺旋	F6500 F3000	7150Lm 6800Lm	130Lm/W 124Lm/W	Ra80	15,000h	E27	Ø128x228±5mm
80W	 200W 水銀燈	F6500 F3000	11000Lm 9000Lm	138Lm/W 113Lm/W	Ra80	15,000h	E27 E40	Ø152x251±5mm Ø152x259±5mm



高光效



無藍光危害



低頻閃抑制



光生物安全



RoHS





適用電壓



通過
CNS認證

LED 玉蘭燈 系列



功率	取代市售	色溫	光通量	光效	演色性	壽命	燈頭	產品尺寸(mm)
31W	 55W 螺旋	F6500 F3000	3800Lm 3600Lm	123Lm/W 116Lm/W	Ra80	15,000h	E27	Ø87x235±5mm
50W	 105W 螺旋	F6500 F3000	6000Lm 5800Lm	120Lm/W 116Lm/W	Ra80	15,000h	E27	Ø98x274±5mm







LED 圓形燈泡 系列

點亮一盞燈妝點居家氛圍

LED 圓形燈泡系列





功率	取代市售	色溫	光通量	光效	演色性	壽命	燈頭	產品尺寸(mm)
0.7W	 鹵素 小夜燈	F6500 F3000 紅光	32Lm 32Lm 4Lm	46Lm/W 46Lm/W 6Lm/W	Ra80	15,000h 無	E27	Ø45x68±5mm
16W	 21W 省電燈泡	F6500 F3000	1920Lm 1760Lm	120Lm/W 110Lm/W	Ra80	15,000h	E27	Ø95x169±5mm



LED 圓形燈泡系列



功率	取代市售	色溫	光通量	光效	演色性	壽命	燈頭	產品尺寸(mm)
20W	 21W以上 省電燈泡	F6500 F3000	1600Lm 1500Lm	80Lm/W 75Lm/W	Ra75	15,000h	E27	Ø125x185±5mm
25W	 36W以上 省電燈泡	F3000	1900Lm	76Lm/W	Ra75	15,000h	E27	Ø145x205±5mm



無藍光危害



低頻閃抑制



光生物安全



RoHS



適用電壓

LED 飛碟燈系列

人文設計的美學 餐桌上的光氛圍

LED 飛碟燈 系列

新品上市





10W
(素面款)



10W
(星空款)



12.5W
(聚光透鏡款)

款式	功率	取代市售	色溫	光通量	光效	演色性	燈頭	產品尺寸(mm)
素面款	10W	 19W 螺旋	F6500 F4000 F3000	1060Lm 1060Lm 1060Lm	106Lm/W 106Lm/W 106Lm/W	Ra80	E27	Ø138x72.5±5mm
星空款	10W	 19W 螺旋	F6500 F4000 F3000	1060Lm 1060Lm 1060Lm	106Lm/W 106Lm/W 106Lm/W	Ra80	E27	Ø138x72.5±5mm
聚光透鏡款	12.5W	 19W 螺旋	F6500 F3000	1055Lm 1055Lm	84Lm/W 84Lm/W	Ra80	E27	Ø135x55±5mm



無藍光危害



低頻閃抑制



光生物安全



RoHS



適用電壓



通過
CNS認證

LED 嵌燈系列

高亮度 / 防觸電材質 / 安裝快速

LED 可調角度嵌燈 系列



5W

9W

功率	色溫	光通量	光效	演色性	壽命	開孔尺寸	聚光角度	產品尺寸(mm)
5W	F6500 F4000 F3000	450Lm	90Lm/W	Ra80	15,000h	Ø7.5cm	36°	Φ95x23.5±5mm
9W	F6500 F4000 F3000	810Lm	90Lm/W	Ra80	15,000h	Ø9.5cm	36°	Φ112x28.5±5mm



附加快接端子



無藍光危害



低頻閃抑制



光生物安全



RoHS



適用電壓



通過
CNS認證

LED 超薄嵌燈 系列



功率	色溫	光通量	光效	演色性	壽命	開孔尺寸	產品尺寸(mm)
12W	F6500	1200Lm	100Lm/W	Ra80	15,000h	Ø12cm	Ø140x28±5mm
	F4000	1200Lm	100Lm/W				
	F3000	1140Lm	95Lm/W				
15W	F6500	1550Lm	103Lm/W	Ra80	15,000h	Ø15cm	Ø170x34±5mm
	F4000	1550Lm	103Lm/W				
	F3000	1425Lm	95Lm/W				



附加快接端子



無藍光危害



低頻閃抑制



光生物安全



RoHS



適用電壓



通過
CNS認證

LED 防水嵌燈 系列

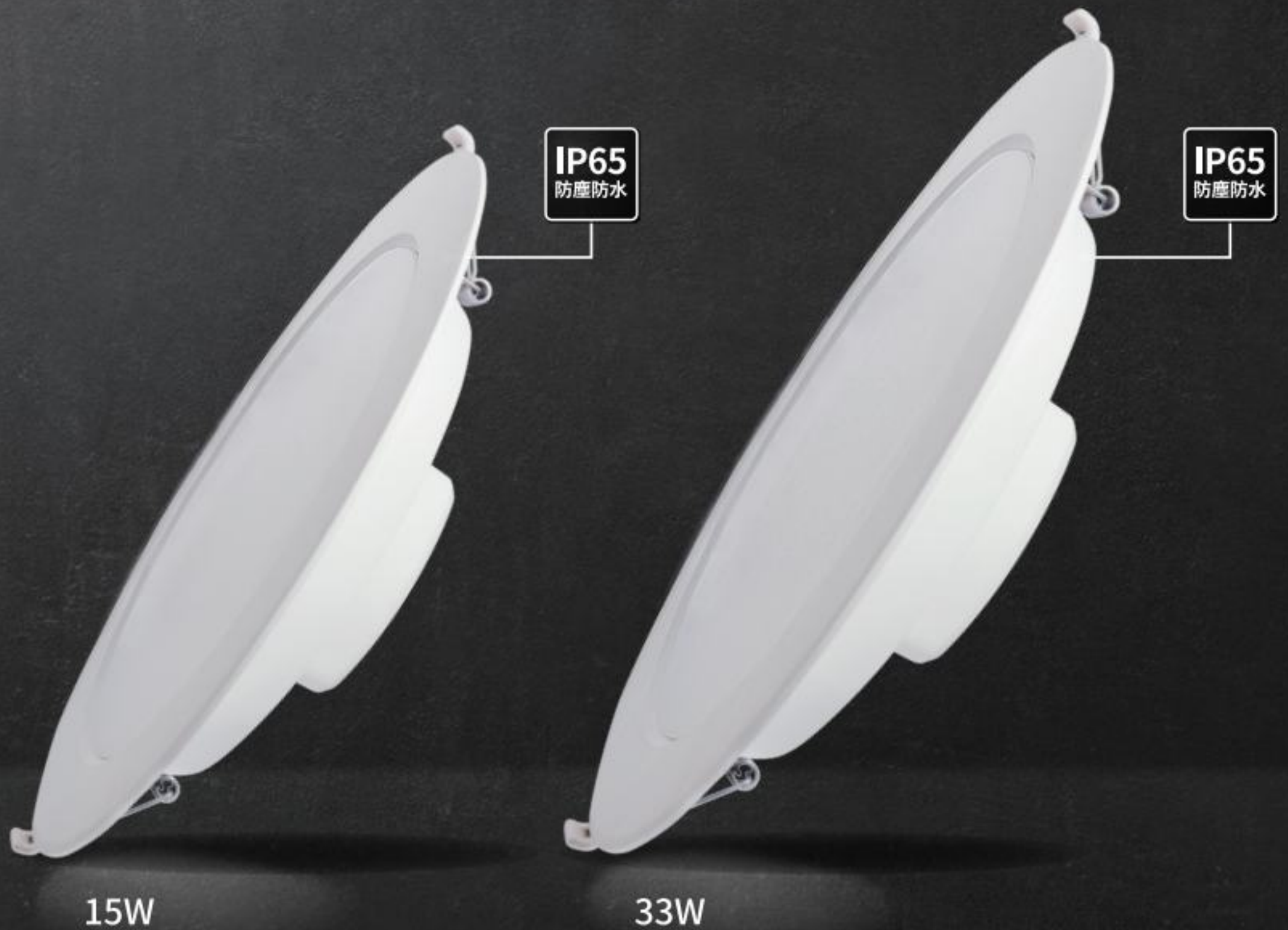

功率	色溫	光通量	光效	演色性	壽命	開孔尺寸	防護等級	產品尺寸(mm)
15W	F6500	1550Lm	103Lm/W	Ra80	15,000h	Ø15cm	IP65	Ø187x45±5mm
	F4000	1550Lm	103Lm/W					
	F3000	1425Lm	95Lm/W					
33W	F6500	2600Lm	79Lm/W	Ra80	15,000h	Ø20.5cm	IP65	Ø260x57±5mm
	F4000	2600Lm	79Lm/W					
	F3000	2600Lm	79Lm/W					



- 
附加快接端子
- 
無藍光危害
- 
低頻閃抑制
- 
光生物安全
- 
RoHS
- 
適用電壓
- 
通過
CNS認證

LED MR16免安杯燈 系列





功率	取代市售	色溫	光通量	光效	演色性	光束角	燈頭	產品尺寸(mm)
5W	 30W 鹵素燈	F6500 F4000 F3000	550Lm 550Lm 500Lm	110Lm/W 110Lm/W 100Lm/W	Ra80	20°	GU5.3 GU10 E27 E14	Ø50x50±5mm Ø50x54±5mm Ø50x56±5mm Ø50x63.5±5mm

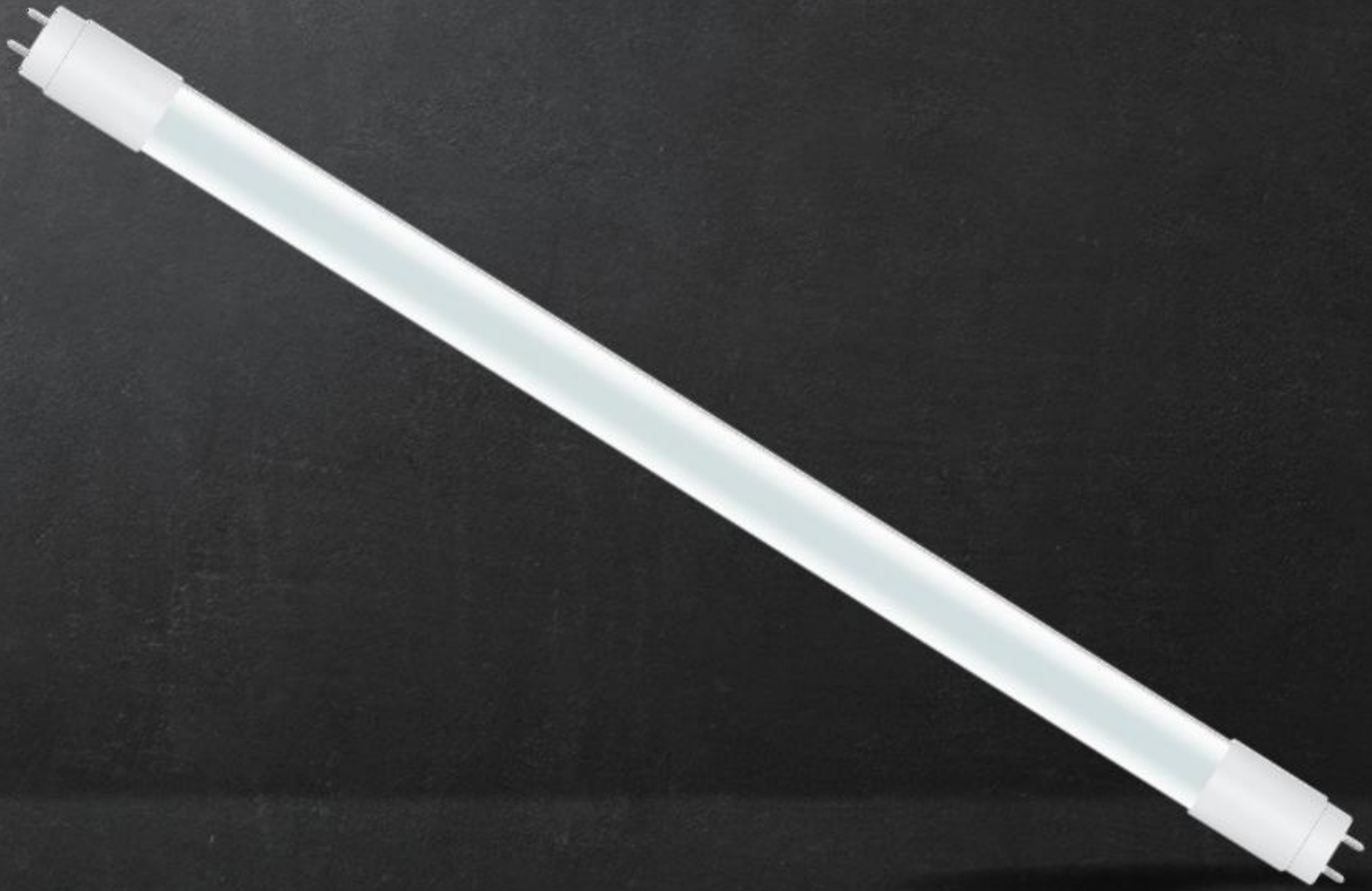

LED T8玻璃燈管 系列







款式	功率	取代市售	色溫	光通量	光效	演色性	燈頭	產品尺寸(mm)
1呎	6W 5W	 10W 傳統燈管	F6500 F3000	660Lm 550Lm	110Lm/W 110Lm/W	Ra82	G13	Ø27x330±5mm
2呎	10W	 20W 傳統燈管	F6500 F4000 F3000	1200Lm 1200Lm 1100Lm	120Lm/W 120Lm/W 110Lm/W	Ra82	G13	Ø27x580±5mm
4呎	20W	 40W 傳統燈管	F6500 F4000 F3000	2400Lm 2400Lm 2200Lm	120Lm/W 120Lm/W 110Lm/W	Ra82	G13	Ø27x1199±5mm



LED T5全塑支架燈 系列



款式	功率	取代市售	色溫	光通量	光效	演色性	燈頭	產品尺寸(mm)
1呎	5W	 8W 傳統T5	F6500 F4000 F3000	500Lm 500Lm 500Lm	100Lm/W 100Lm/W 100Lm/W	Ra80	2pin	24x38x339±5mm
2呎	10W	 14W 傳統T5	F6500 F4000 F3000	1000Lm 1000Lm 1000Lm	100Lm/W 100Lm/W 100Lm/W	Ra80	2pin	24x38x600±5mm
3呎	15W	 21W 傳統T5	F6500 F4000 F3000	1500Lm 1500Lm 1500Lm	100Lm/W 100Lm/W 100Lm/W	Ra80	2pin	24x38x898±5mm
4呎	20W	 28W 傳統T5	F6500 F4000 F3000	2000Lm 2000Lm 2000Lm	100Lm/W 100Lm/W 100Lm/W	Ra80	2pin	24x38x1199±5mm



無藍光危害



低頻閃抑制



光生物安全



RoHS



適用電壓



通過
CNS認證

LED 超薄平板燈



40W

新品上市

款式	功率	取代市售	色溫	光通量	光效	演色性	壽命	產品尺寸(mm)
2呎x2呎	40W	 傳統2呎x2呎 輕鋼架燈具	F6500 F4000 F3000	4000Lm 4000Lm 4000Lm	100Lm/W 100Lm/W 100Lm/W	Ra80	15,000h	600x600x35±5mm



低眩光





適用電壓



通過
CNS認證

LED 水晶燈 系列



款式	功率	取代市售	色溫	光通量	光效	演色性	燈頭	產品尺寸(mm)
白色	5W	 40W 鎢絲燈	F6500 F3000	525Lm 525Lm	105Lm/W 105Lm/W	Ra80	E14	尖清 Ø35x103±5mm 拉尾 Ø35x121±5mm
金色	7W	 40W 鎢絲燈	F6500 F3000	400Lm 400Lm	60Lm/W 60Lm/W	Ra95	E14	尖清 Ø38x118±5mm 拉尾 Ø38x145±5mm

*金色水晶燈另有調光版本



無藍光危害



低頻閃抑制



光生物安全



RoHS



適用電壓



通過
CNS 認證

LED戶外投光燈



30w



50w



100w



150w



200w

新品上市

功率	色溫	光通量	光效	演色性	尺寸
30w	F6500 F4000 F3000	3000Lm	100Lm/W	Ra80	189*132 *27mm

功率	色溫	光通量	光效	演色性	尺寸
50w	F6500 F4000 F3000	5000Lm	100Lm/W	Ra80	240*166 *27mm

功率	色溫	光通量	光效	演色性	尺寸
100w	F6500 F4000 F3000	10000Lm	100Lm/W	Ra80	340*230 *31mm

功率	色溫	光通量	光效	演色性	尺寸
150w	F6500 F4000 F3000	15000Lm	100Lm/W	Ra80	405*273 *31mm

功率	色溫	光通量	光效	演色性	尺寸
200w	F6500 F4000 F3000	20000Lm	100Lm/W	Ra80	508*317 *35mm

LED吸頂燈



星鑽



星空



滿月

新品上市

新功能：導眠、靜音

功能類型	功率	色溫	光通量	光效	演色性
遙控多段調光調色	35w	F6500 F4000 F3000	3500Lm	100Lm/W	Ra80
功能類型	功率	色溫	光通量	光效	演色性
遙控多段調光調色	50w	F6500 F4000 F3000	5000Lm	100Lm/W	Ra80
功能類型	功率	色溫	光通量	光效	演色性
遙控多段調光調色	120w	F6500 F4000 F3000	15000Lm	125Lm/W	Ra80

功能類型	功率	色溫	光通量	光效	演色性
單色	50w	F6500 F4000 F3000	5000Lm	100Lm/W	Ra80

LED軌道燈



8w



12w/20w/30w

新品上市

功率	色溫	光通量	光效	演色性
8w	F6500 F4000 F3000	640Lm	80Lm/W	Ra80

功率	色溫	光通量	光效	演色性
12w	F6500 F4000 F3000	960Lm	80Lm/W	Ra80

功率	色溫	光通量	光效	演色性
20w	F6500 F4000 F3000	1800Lm	90Lm/W	Ra80

功率	色溫	光通量	光效	演色性
30w	F6500 F4000 F3000	2700Lm	90Lm/W	Ra80